

LCD-401B

 30kgs (66lbs)max.

 10-30" (25-74cm)max.

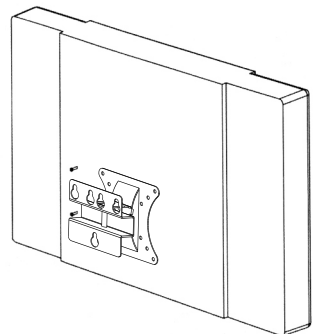

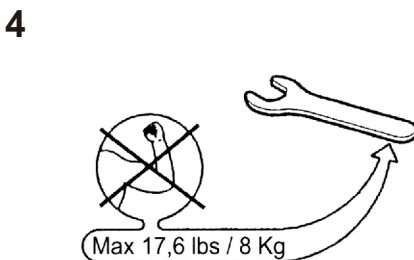
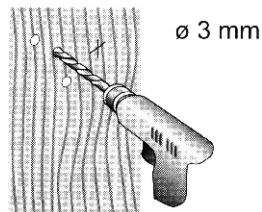
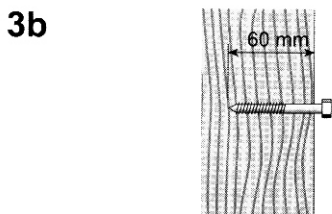
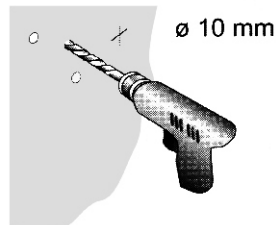
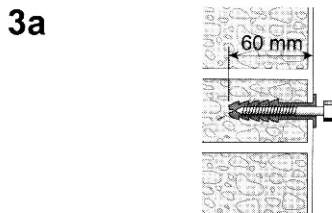
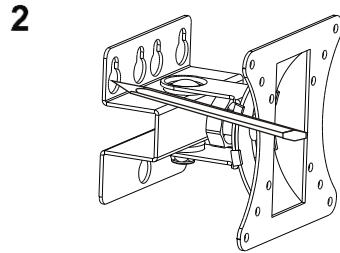
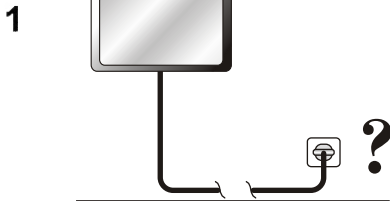
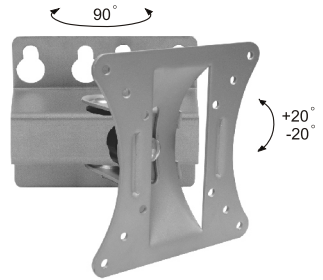
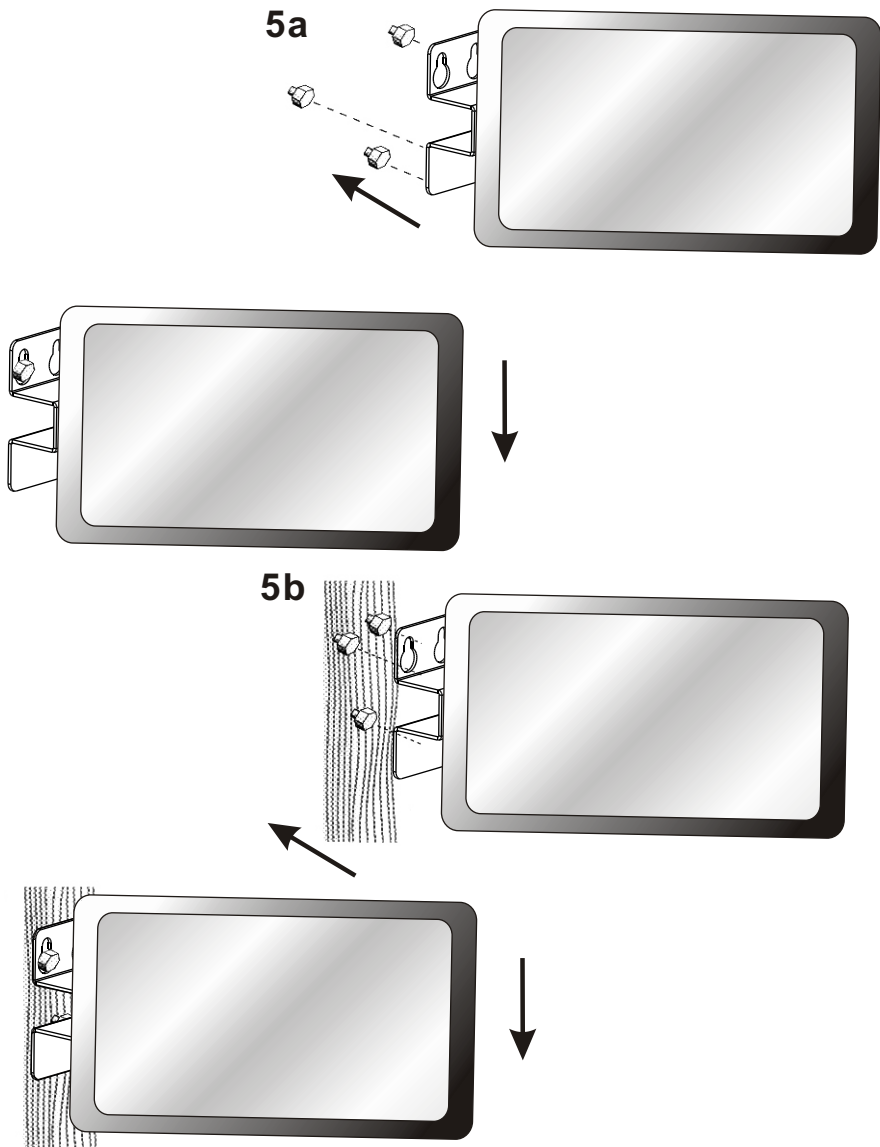

Safety instructions

- Never fit defective parts
- Only suitable for walls made from: Stone, concrete, hollow blocks, solid wood or wood supports. If mounting on wood, do not use any raw plugs. Pre-drill to a depth of 2mm. The fixing material supplied is only suitable for the types of wall listed above. Walls made from other materials will require different fixing materials.
- If you are uncertain about the nature of your wall, consult an expert.